User Manual

Low power mobile data logger

ThingsLog LPMDL-1102

NB-IoT Data logger

♥ iTransformers Labs Ltd

11 Magnaurska shkola str., fl. 3, office 315 (Hightech Business Park, BIC IZOT),

1784, Sofia, Bulgaria

Phone (+359) 875 32 80 70 • Email: info@thingslog.com

Contents

1	Overview	3
2	Technical specification	3
3	Functional specification	4
4	Safe and Healthy instructions	5
5	Physical installation	7
6	Input/Output ports	8
7	Replacing the batteries	10
8	User guide	10
8.1	Login to ThingsLog platform	10
8.2	Initial configuration ThingsLog LPMDL-1102	10
8.3	Normal operation mode & short functional description	14
8.3.1	Readings	14
8.3.2	Flow graph	15
8.3.3	Cumulative graph	16
8.3.4	Data export	16
8.3.5	Dashboard	16
8.3.6	Battery status	18
8.3.7	Signal status	19

1 Overview

ThingsLog LPMDL-1102 is a universal, low power mobile data logger able to meter various kinds of pulse meters and analog sensors. The logger is transmitting the metered data over 4G/NB IoT.

LPMDL-1102 has the following key characteristics:

Optimal data transmissions - LPMDL-1102 is able to transmit the data over a two way 4G/NB IoT network in an optimal for the battery way. That allows the logger to meter per minute, to transmit a couple of times per day and still to achieve more than 10 years of battery life.

Intelligence - the data is transmitted over a widely distributed, cellular network and is automatically gathered in ThingsLog platform.

Pulse metering - LPMDL-1102 has ability for an independent counting of pulse output meters for water, gas, power and heating. With a single data logger you can meter two meters for example for cold and hot water or if your meters are in proximity distance you can meter with a single device gas, power and heating.

Analog sensors metering - LPMDL-1102 has two extra inputs for connecting analog sensors with 4-20 mA output. An example could be connecting two pressure sensors or one pressure and one temperature sensor.

Combined monitoring - LPMDL-1102 can fulfill use cases where with a single logger have to be monitored one water meter and two pressure sensors. For example monitoring of pressure reduction areas by measurements of pressure sensors before and after the pressure reduction valve and its water meter.

Alarms and notifications - LPMDL-1102 together with the ThingsLog platform is able to monitor consumption and notify the customer or the utility company for leaks, high or low consumption, fraud or thresholds bridging of certain sensor value or a combination of a sensor and metered value.

Application - LPMDL-1102 fulfills various use-cases in water, power and gas distribution utilities but also many other use-cases in property management, hotel, manufacturing, condominium sub-metering or in common need is spread.

Ability to work in any environment - LPMDL-1102 has IP68 dust and leakage protection and is suitable for any kind of home or industrial usage.

2 Technical specification

Length	132.3 mm / 5.2 in 155 mm / 6.1 in
--------	--

Height	52 mm / 2.04 in
Width	70 mm / 2.75 in
Weight	130 gram
Temperature range:	-40 - +60 °C
Frequency	B1 @H-FDD: 2100MHz B3 @H-FDD: 1800MHz B8 @H-FDD: 900MHz B5 @H-FDD: 850MHz B20 @H-FDD: 800MHz B28 @H-FDD: 700MHz
Transmit power	23dBm±2dB
Sensitivity	129dBm±1dB: -
Cable length	1m, 2m, 3m, 4m, 5m
Physical data transmission layer	NB IoT
MAC layer	Single Tone: DL: 25.2kbps ^[SEP] UL: 15.625kbps ^[SEP] Multi Tone: DL: 25.2kbps ^[SEP] UL: 54kbps ^[SEP] TBS/2 HARQ*: DL 125kbps ^[SEP] UL 150kbps ^[SEP]
Dust & Water protection	IP68
SIM form factor	3FF (MicroSIM)
Battery power	3.6 V, 1 A or size C lithium battery

Table I Technical specification

3 Functional specification

- **Pulse metering:** the logger supports pulses generated by reed contacts, hol sensors or SO pulse outputs of water, gas and electricity meters
- **Analog sensor metering:** The logger supports analog sensors with output from 4 to 20 mA such as pressure sensors like Wika, IFM and others
- **Data transmission:** LPMDL-1102 support NB-IoT . Data is transmitted over raw UDP socket
- **Low powered:** Preinstalled interchangeable long life battery able to support more than 10000 transmissions of millions of individual counter values
- **Average battery life:** 10 years
- **Built-in antenna**
- **Reconfigurability over the air:** ability to reconfigure the logger reading and transmission rates over

the air

- Secured configuration
- Replaceable micro sim card
- Certified for both industrial and home usage

4 Safe and Healthy instructions

Important information	<p>Please read the complete information, the specifications, the installation instruction and the electrical interconnect schema prior to working with this product.</p> <p>For your own health and safety and for the equipment to function correctly please ensure that you understand completely the contents of this guide, prior installation, configuration, operations or prophylactics.</p>
CE	<p>From license point of view, unauthorized modifications or additions are not authorized.</p>
Terms of use	<p>The data logger is intended for use in the following environmental conditions:</p> <ul style="list-style-type: none"> ● for use indoors or outdoors without prolonged exposure to direct UV radiation ● for altitudes up to 2000 m ● for ambient temperatures from -40 ° C to + 60 ° C, with continuous exposure to temperatures of -20 to -40 ° C not recommended ● for relative humidity of 4% to 100% ● for supply voltage deviation of up to + 20% and -15% of declared voltage ● for use under the overvoltage category I; ● for environment with pollution degree 3 (PD3).
Health and safety rules for installation	<p>All installation work must be performed in accordance with the local regulations on health and safety at work in electrical systems as well as the regulations governing the electrical system and networks.</p> <p>Only engineers or technicians with product expertise that has previously read and understood this guide should install this product.</p>

<p>Installation and maintenance</p>	<p>Installation is done in accordance with the instructions in this document. Incorrect installation may cause damage to the logger and inaccurate measurements. That is why the installation, the initial configuration must be done with due attention.</p> <p>Incorrect installation results in violation of warranty conditions and failure of the warranty.</p> <p>An example of improper installation is to connect the pulse or analog input of the device shortly or to a power source</p>
<p>Transport and storage</p>	<p>Store in dry rooms without access to water or other liquids at temperatures not lower than -20 ° C and not higher than 60 ° C in the original package. Transportation is allowed to happen accidentally at temperatures below -20 ° C but not more than 8 hours. Protect against shocks and avoid extreme conditions.</p>
<p>Subsequent maintenance</p>	<p>Once installed, the data logger should be cleaned using a dry or lightly moistened cloth, explicitly prohibiting the use of aggressive and abrasive detergents.</p> <p>Every six months, it is desirable for the user of the logger to check the enclosure integrity and the integrity and waterproofness of the cable and connecting terminals to the measured device or sensor.</p>
<p>Recycling</p>	<p>When recycling the product and its disposal, local and national legislation and regulations must be observed. If you hesitate, please return the appliance, we will recycle it for you.</p>

Table II Health and safety instructions

5 Physical installation

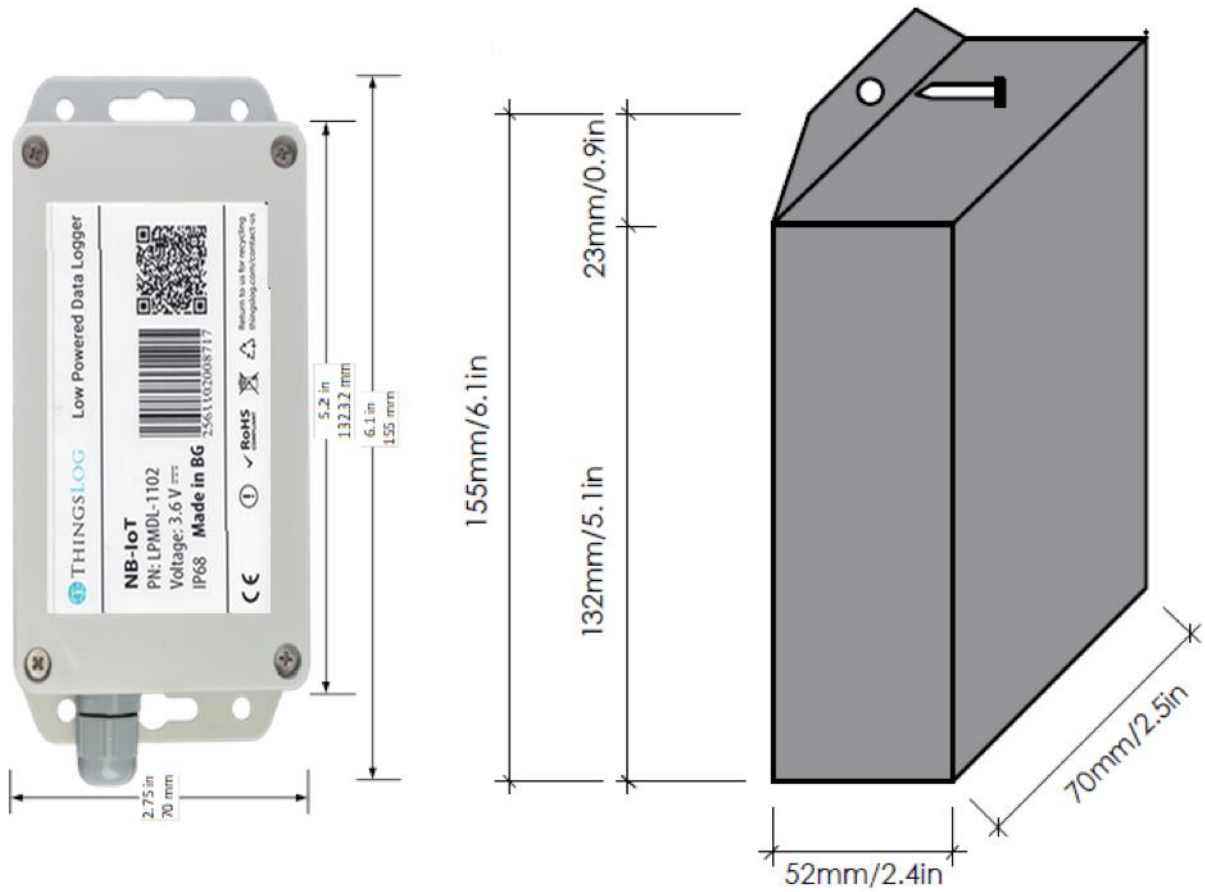

Figure 1 Logger outlook and dimensions

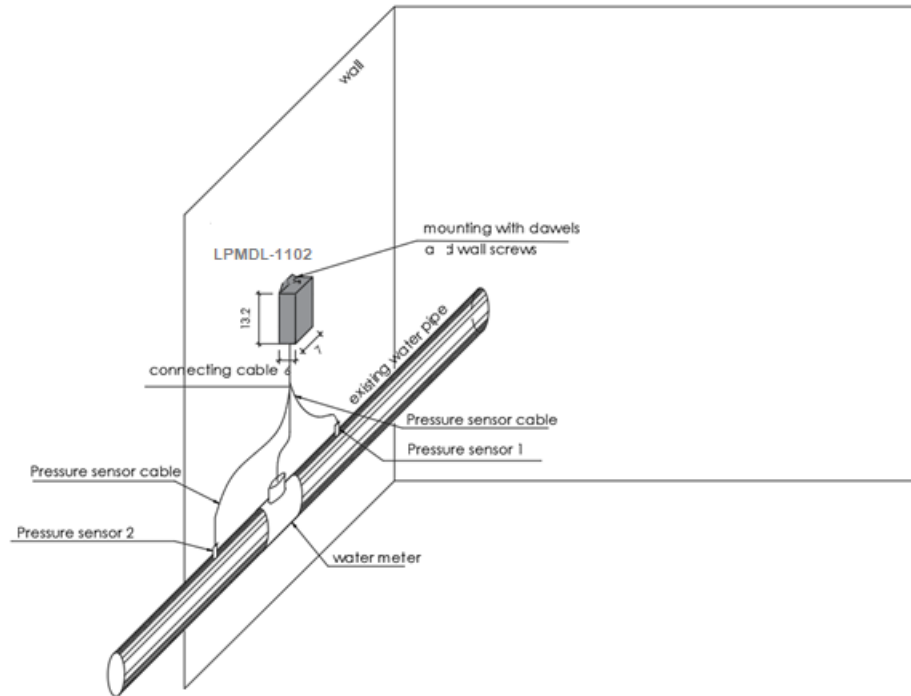

Figure 2 Example installation schema for interconnecting LPMDL-1102 with a water meter and two pulse sensors

- Prior to install the logger please review the health and safety instructions described in chapter 3.
- The data logger is coming with an installation manual and a kit through which it can be attached to a firm surface.
- In order to attach the logger you will need a wall with stiff, flat surface close to the meter or the sensor which you would like to measure.
- Mark and drill holes with size 4x25 mm for attaching the logger to the wall.
- Attach the logger input/outputs to the connecting cable.
- Attach the corresponding connecting cable input/outputs to the meters/sensors.

6 Input/Output ports

LPMDL-1102 has 12 input/output ports. To access the ports unscrew the board from the bottom of the logger enclosure and lift it up.

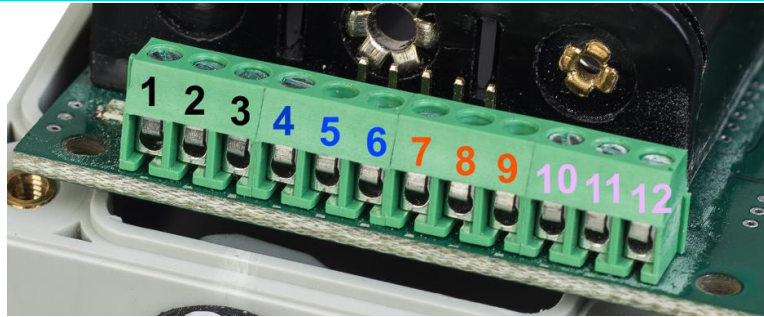

Figure 3 Logger input/output ports

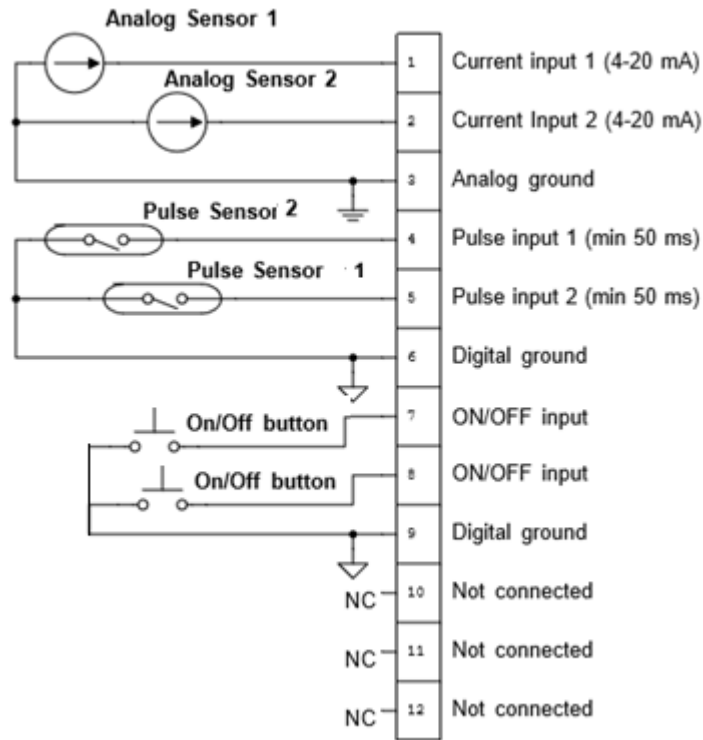

Figure 4 LPMDL-1102 wiring scheme

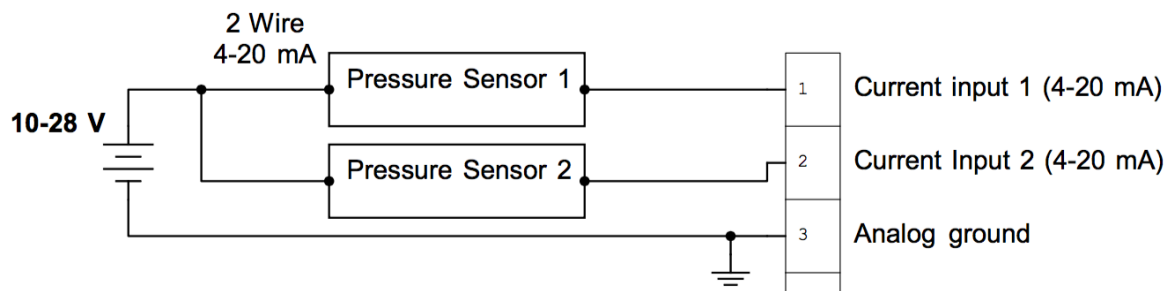

Figure 5 Wiring scheme for pressure monitoring with two sensors and external battery source

7 Replacing the batteries

LPMDL-1102 requires one size A or C 3,6V batteries. LPMDL-1102 could also be ordered with a battery holder for 2xAA 1.5 batteries.

ThingsLog platform has built-in battery monitoring capabilities. The batteries have to be replaced if the voltage level is under 3.1 V for the 3.6 V batteries or under 2.8 V for the 2xAA 1.5 Batteries.

8 User guide

8.1 Login to ThingsLog platform

1. In order to perform the initial configuration you should have an account for ThingsLog IoT platform. If you don't have an account please contact us at support@thingslog.com.
2. Once you have the account navigate to <https://iot.thingslog.com>
3. You should be able to see a device list with the devices associated to your profile.

8.2 Initial configuration ThingsLog LPMDL-1102

1. Connect your logger to your meters and sensors as described in section physical installation.
2. Navigate to menu "All Devices" - and pick your newly added logger.

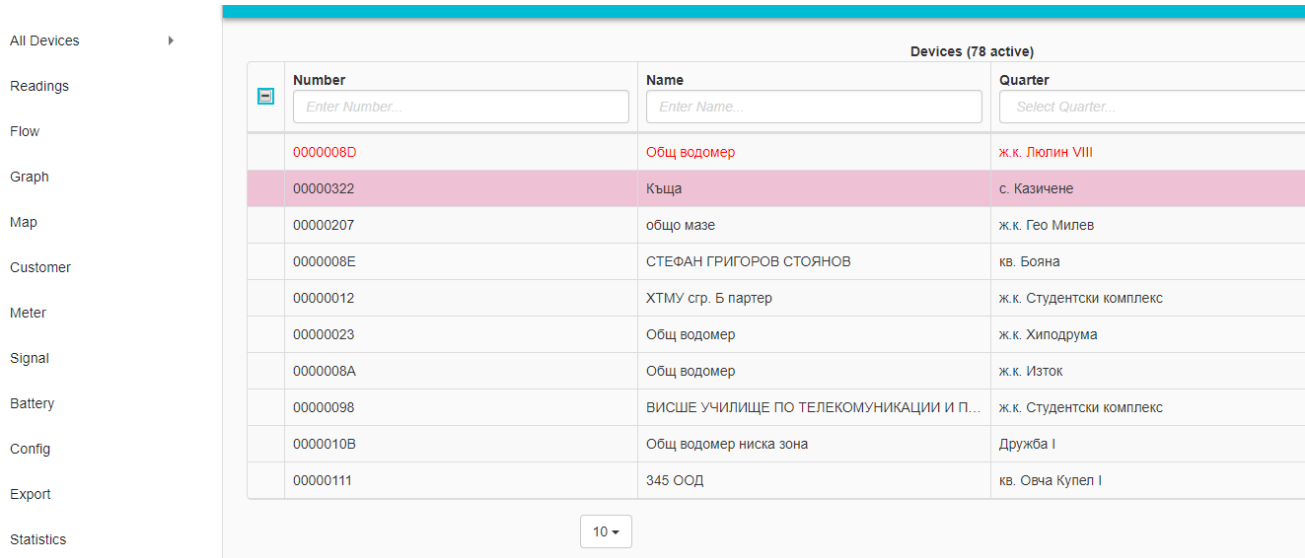

The screenshot shows the 'All Devices' menu on the left with a list of devices on the right. The table has three columns: Number, Name, and Quarter. The second row is highlighted in pink.

Devices (78 active)		
Number	Name	Quarter
000008D	Общ водомер	ж.к. Люлин VIII
00000322	Къща	с. Казичене
00000207	общо мазе	ж.к. Гео Милев
000008E	СТЕФАН ГРИГОРОВ СТОЯНОВ	кв. Бояна
00000012	ХТМУ сгр. Б партер	ж.к. Студентски комплекс
00000023	Общ водомер	ж.к. Хиподрума
0000008A	Общ водомер	ж.к. Изток
00000098	ВИСШЕ УЧИЛИЩЕ ПО ТЕЛЕКОМУНИКАЦИИ И П...	ж.к. Студентски комплекс
0000010B	Общ водомер ниска зона	Дружба I
00000111	345 ООД	кв. Овча Купел I

Figure 6 Menu "Devices"

3. From the menu choose "Config" then a similar configuration dialog will appear.

Configure device: 01019516,
Config date: 2020-03-05 12:32:35
Status: Configured

Record and transmission periods ^

Transmission Period
24 hours

Record Period
30 minutes

Pulse Sensor 1 ^
Initial Reading: 0.00 m³

Initial Reading

0	0	0	0	0	,	0	0
---	---	---	---	---	---	---	---

+ Digits - + Fraction -

Sensor Type
Generic Digital Sensor

Units Type
m³

Pulse per m³
0.01

Pulse Sensor 2 v
Initial Reading: 0.00 m³

Figure 7 Configuration dialog

On the top you can see the logger id, date when it was configured for a last time and current configuration status.

Then follows the common section for all inputs/outputs.

- *Transmission period* - Number of minutes/hours/days between the logger scheduled transmissions
- *Record period* - Could be Minutes or Hours. This is the period on which the logger will log in memory the reading values from the pulse inputs or the period on which it will perform low power reading of its analog current inputs.

4. Pulse sensors

Pulse sensors are typically meters connected to a pulse input port or buttons. To enable the port please slide the slider to the right and enter. Once the port is enabled you have to set the following.

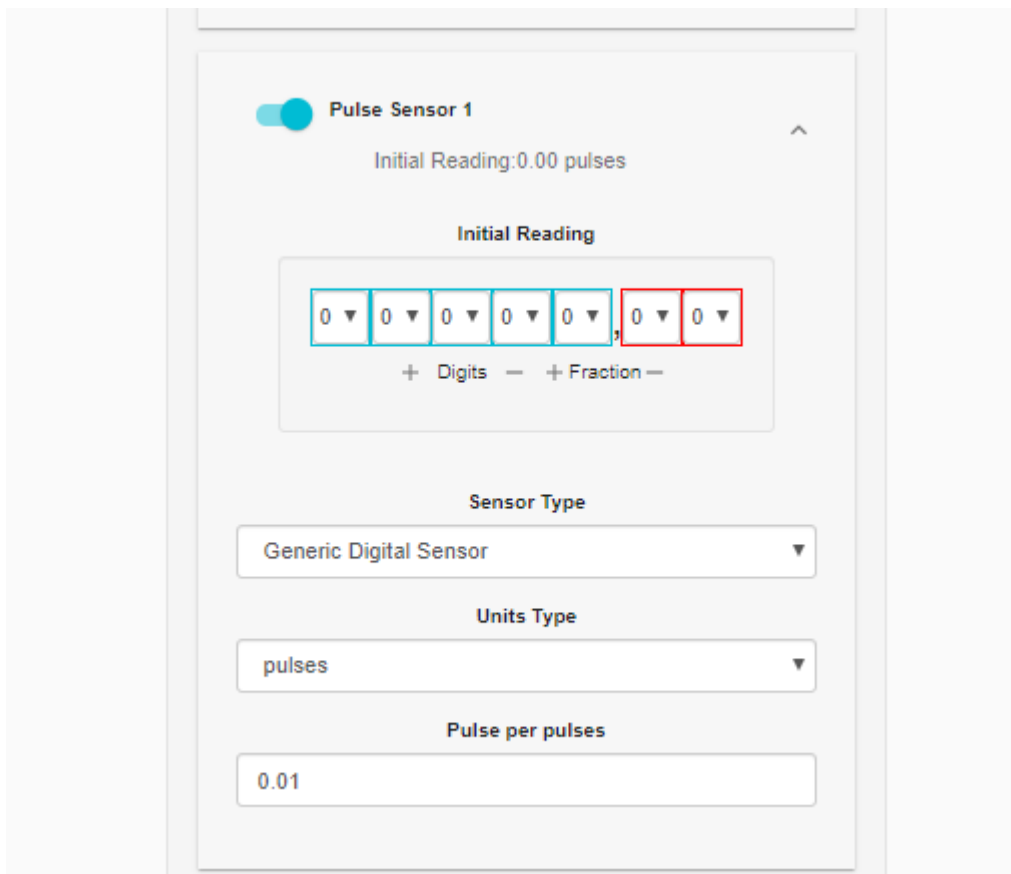

Figure 7 Pulse input port configuration dialog

- *Digits* - Number of digits - equals to the number of digits on the display of the meter
- *Fraction* - Number of digits after the decimal pointer on the display of the meter
- *Initial reading* - Initial value of the counter of the meter

- *Sensor type* – the type of the sensor could be water, gas, power etc meter.
- *Units type* – the dimension of the metered values – m3, kw etc.
- *Pulse per unit* – how much of the measured value is equal to one pulse

5. Analog sensors

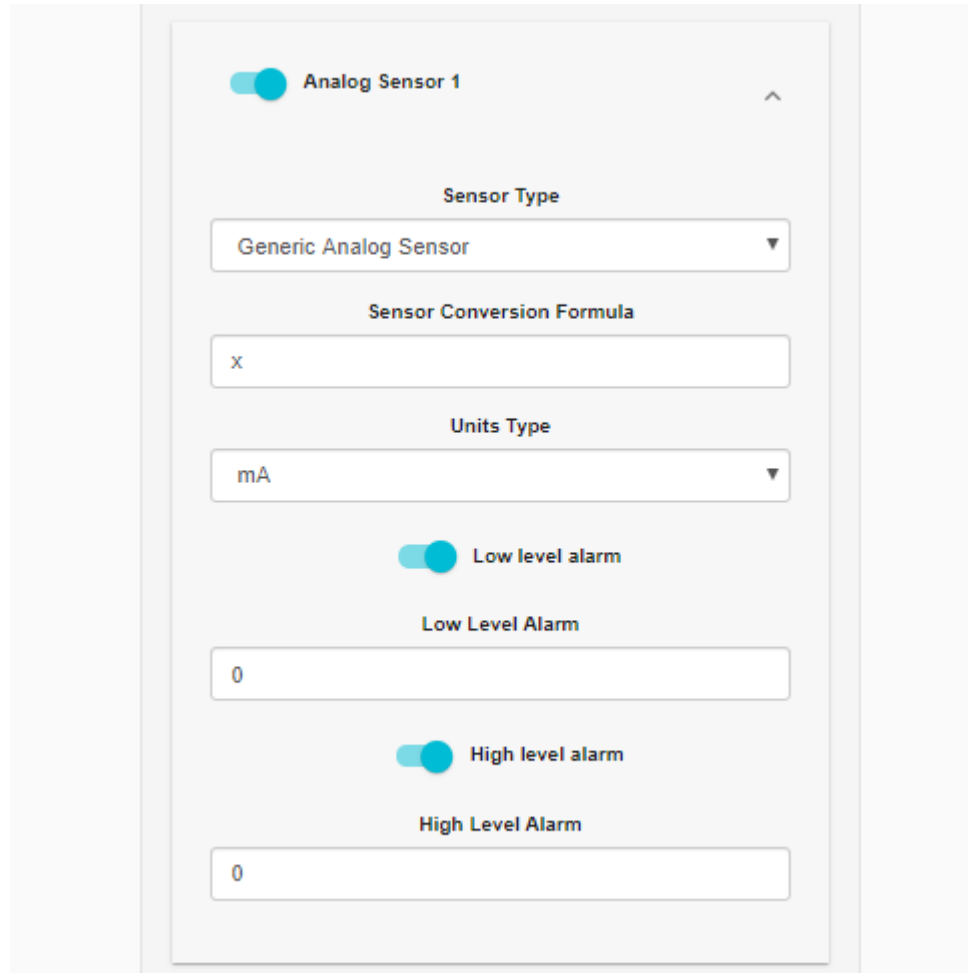

Figure 7 Analog input port configuration dialog

To enable analog sensor readings (connected to the analog inputs) just slide the slider to the right and configure:

- Sensor type – the type of an analog 4-20mA sensor we are measuring
- Sensor conversion formula – convert the “x” into bars or something else based on the formula for conversation of mA to the required dimension of your sensor. If you leave it as x you will get values in mA.
- Units type – the type of the unit – mA, bar, etc.
- Low Level Alarm – Instant alarm for reaching certain low level analog sensor value
- High Level Alarm - Instant alarm for reaching certain high level analog sensor value

6. ON/OFF sensors

To enable the ON/OFF sensors slide the slider to the right. The sensors has to be normally open ON/OFF sensors. If the port is enabled and the sensor goes from OFF to ON the logger will wake and will transmit an instant alarm.

7. *Delete old counters* - once you are ready with the inputs configuration decide do you want to keep the old values or not. If not choose "NO" else chose "YES".

8. Once you are ready press "**Start Setup**" button.

This will start a 1000 seconds counter. You will have to touch the logger with a magnet prior the counter expiry. This will put the logger into configuration mode and it will try to obtain its configuration from the server.

9. If the logger get configured successfully you will be able to see the following message on your screen.

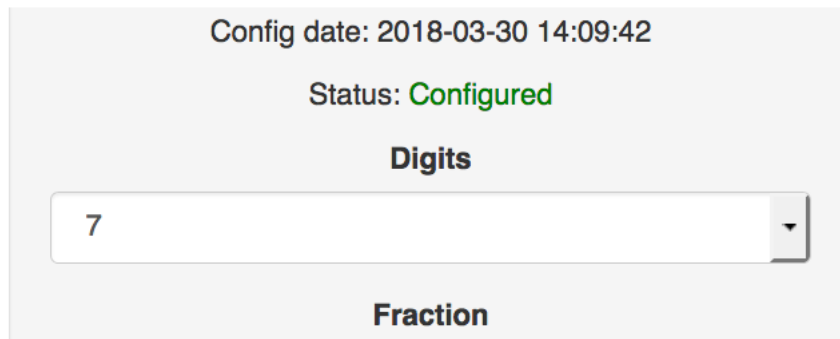

Figure 8 Confirmation of successful configuration

If the configuration process is unsuccessful and the device stays in "Not configured" mode please ensure that the device has been placed in an area with proper GSM coverage. If you are not sure that such is available in your area please let us know at support@thingslog.com.

8.3 Normal operation mode & short functional description

Once configured the logger will start to collect and transmit readings from the attached sensors. The logger supports the following main functionalities:

8.3.1 Readings

From the readings menu the user has access to the readings gathered by the logger. The user can select a time interval and export the readings to a file in csv file format.

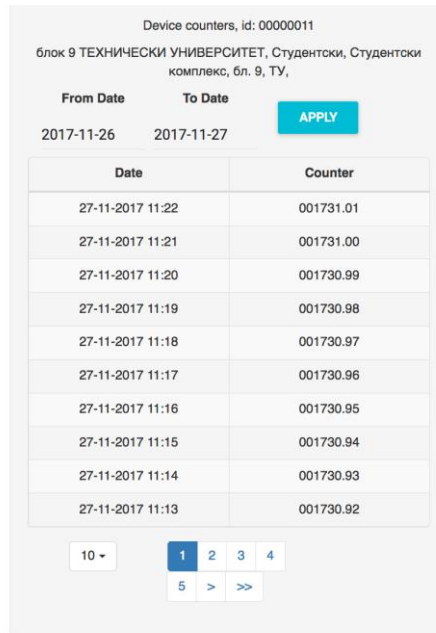

Figure 9 Readings

8.3.2 Flow graph

Flow menu allows the user to visualize the consumption flow of the meter captured by the logger.

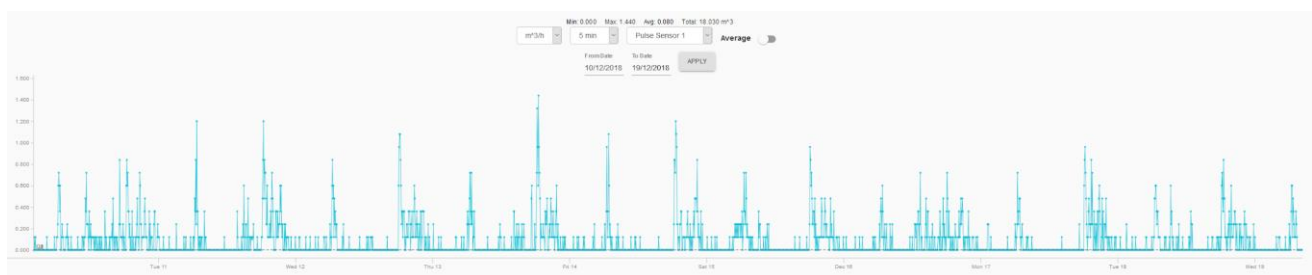

Figure 10 Flow consumption graph

8.3.3 Cumulative graph

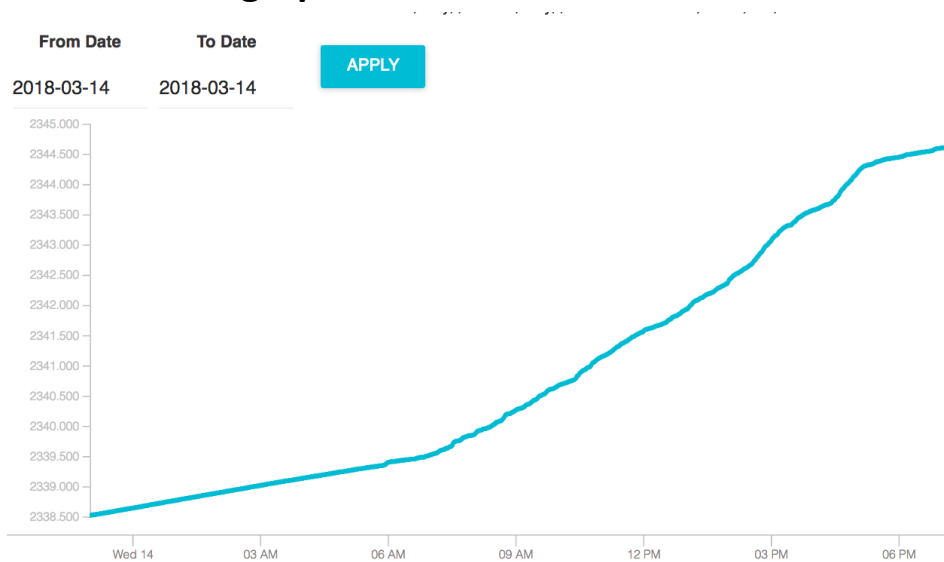
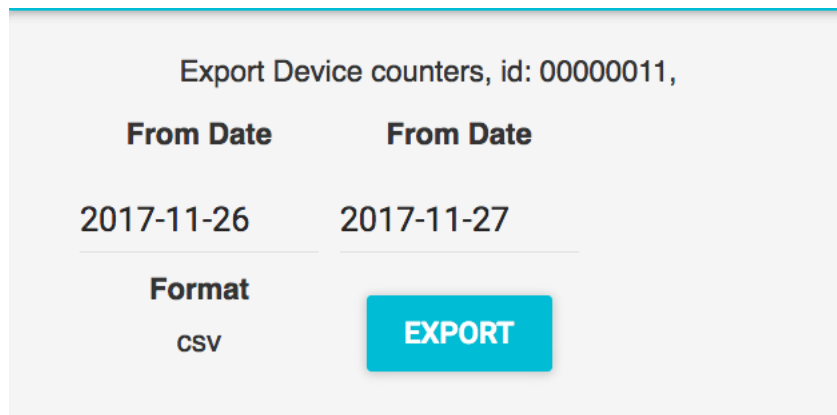

Figure 11 Cumulative consumption graph

8.3.4 Data export

The system supports readings data export from certain time range in CSV file format.



Export Device counters, id: 00000011,

From Date	From Date
2017-11-26	2017-11-27
Format	
csv	EXPORT

Figure 12 Data export in CSV file format

8.3.5 Dashboard

Navigate from the menu to the “Dashboard” where you can verify the operational status of your loggers.

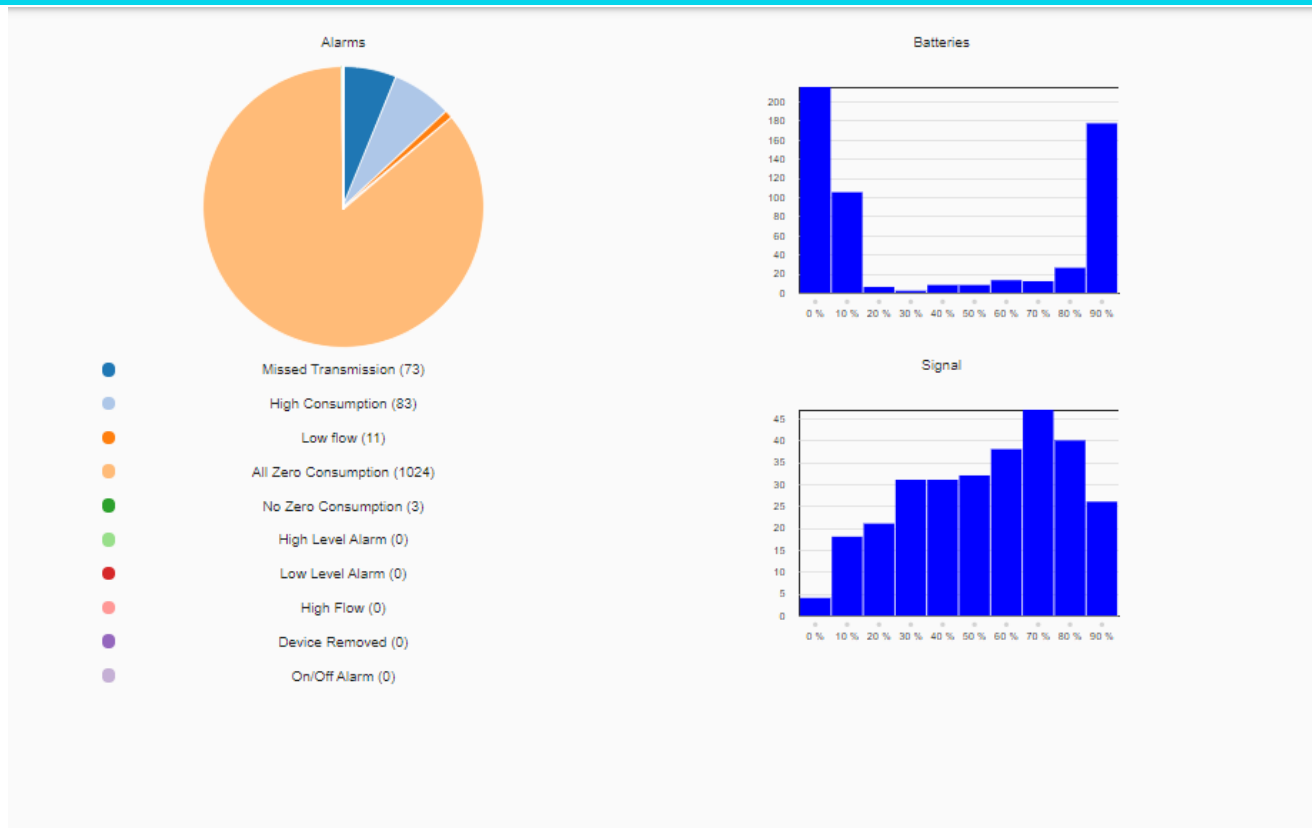

Figure 13 operational status dashboards

ThingsLog™ supports the following kinds of alarms:

- **NO_ZERO_CONSUMPTION** - alarm for non-zero consumption. The non-zero consumption is defined as condition in which the logger is detecting constant consumption over a period equal to the transmission period.
- **HIGH_CONSUMPTION** - alarm indicating consumption higher than a certain preconfigured level over certain period. For example 1m³ over 1 hour.
- **MISSED_TRANSMISSION** - alarm indicating that the transmission from the logger did not happen.
- **LOW_FLOW** - alarm indicating that the flow time interval is lower than the expected value per second.
- **HIGH_FLOW**- alarm indicating that the flow time interval is lower than the expected value per second.
- **HIGH_CONSUMPTION** - alarm indicating that the consumption time interval is lower than the expected one.

- **ALL_ZERO_CONSUMPTION** - alarm signaling zero consumption through certain time-period. For there is no consumption for 24 hours. Could potentially indicate a fault meter.
- **DEVICE_REMOVED** - alarm indicating that the meter has been disconnected from the logger.
- **LOW_BATTERY** - alarm indicating that the battery of the logger is under 20%.
- **ON/OFF alarm** – on/off sensor is enabled and an instant alarm is triggered

8.3.6 Battery status

Battery status in % of your logger. The same could be reviewed in more details if you navigate to “Battery” section of the product.

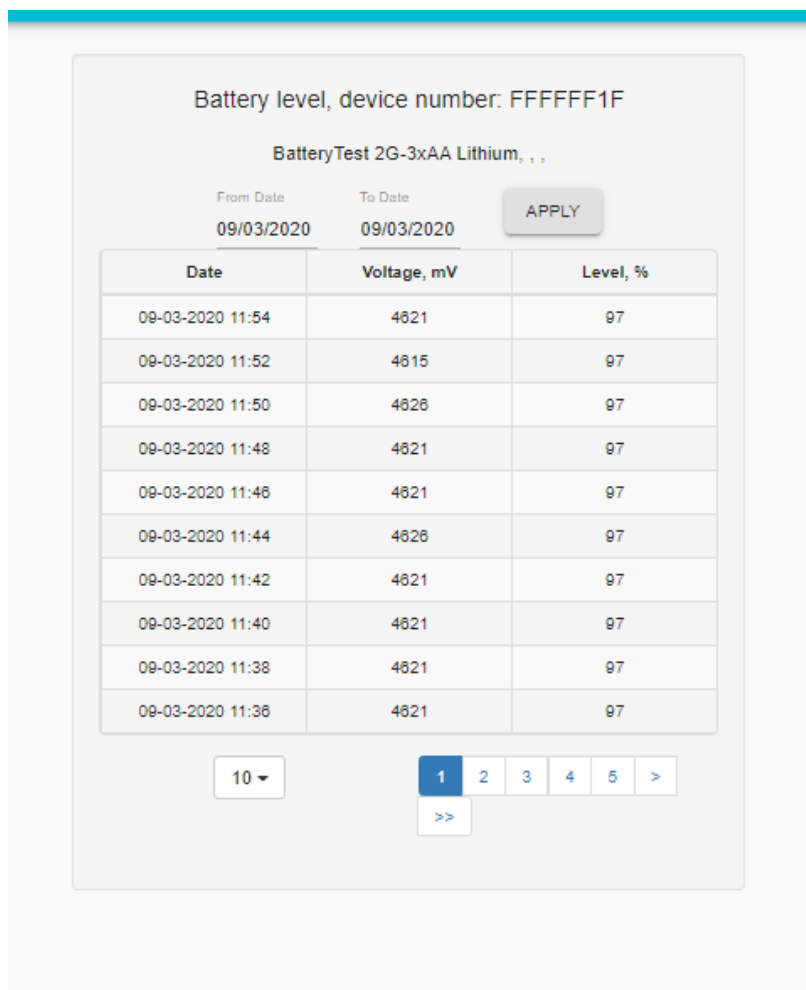

Figure 14 Battery status

Since our loggers are with battery holders we sometimes don't exactly know what kind of a battery is inside the logger. Therefore, the more important value is the voltage in mV. The level in % might be incorrect depending of the type of the logger and the battery you have placed in.

8.3.7 Signal status

On each transmission, the loggers are sending their current measured RSSI (Received Signal Strength Indication) and BER (Bit Error Ratio) if there is an error.

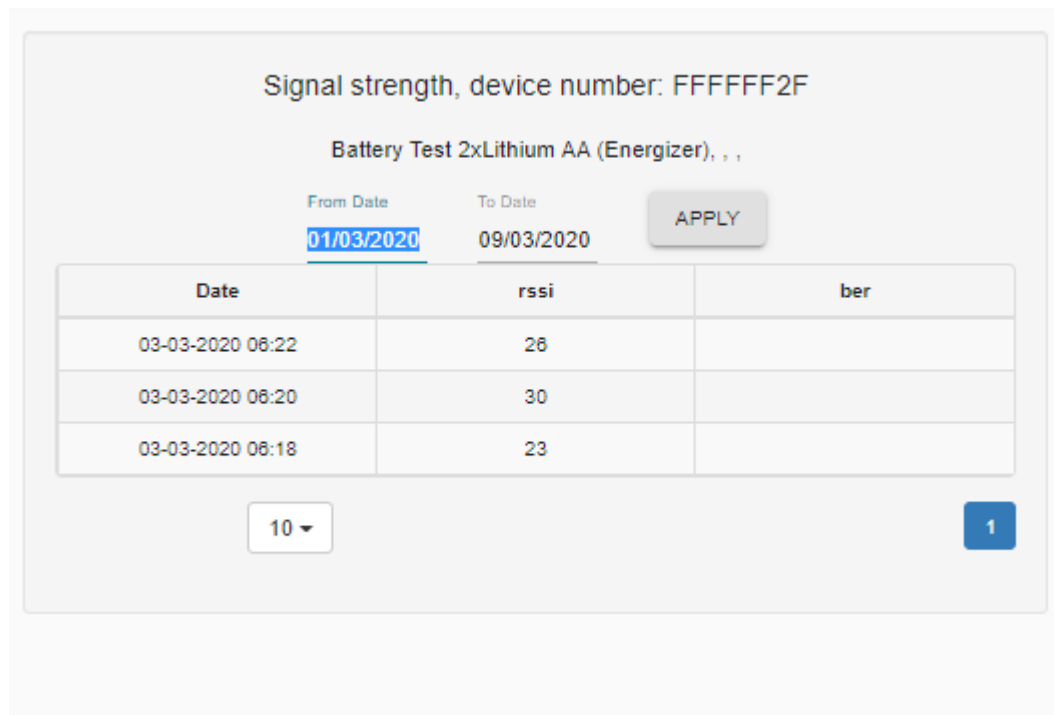

Figure 15 Signal status